



ENGLISH

THE CATALOGUE 2015

Triana

PACKAGING & PHARMA

Triana

THE
CATALOGUE
2015





Triana

THE
CATALOGUE
2015



About us

What defines us?

“We believe that what best expresses who we are is our product and our customers, so, we simply invite you to get to know us better”.

Aleix Triana



Triana

THE
CATALOGUE
2015



The company

Who we are?

Industrias Plásticas Triana is company dedicated to designing and producing plastic containers for the pharmaceutical, food and phytosanitary sectors. Some of its clients are among the leading companies of the sector with a volume of 125 million pieces sold (2014).

The business model

The history of Triana is the history of the plastic sector and the economic development of Spain during the second half of the 20th Century. In 1962, the marriage between Triana Vila was the starting point of an entrepreneurial venture in Barcelona, which nowadays continues keeping its familiar core but with an international presence.

The company bases its model on innovation, flexibility and quality. Through the established infrastructure, Triana offers specific solutions and tools to their customers to achieve competitiveness in their markets. Teamwork built on human relations that we care for on a daily basis.

Triana is a company capable of adapting to the needs of each of its customers. True to its origins and legacy, its customers are the assets of the company. At pre-

sent, Tirana employs 60 people focused on the production for their customers and to provide technical solutions for each situation, which is something that has permitted a considerable development of its activity at an international level in recent years.

The production

With 1,550 tm of transformed material (2014), the totality of our production is carried out in the factory in Barcelona (Spain). Triana sources material directly.

90% of our external suppliers are in Spain. We value their popularity and the importance of teamwork.

We consider production as a joint task and to be able to count on a network of trustworthy suppliers is tantamount for our product.



Triana's worldwide presence since 2006:

- Poland
- Brazil
- Malta
- Cameroon
- Cyprus
- Greece
- United States of America
- United Kingdom
- Morocco
- Algeria
- Switzerland
- Venezuela
- Ireland
- Tunisia
- Andorra
- Czech Republic
- Holland (The Netherlands)
- Mexico
- Germany
- Israel
- Italy
- France
- Portugal
- Spain



Exports versus billing:

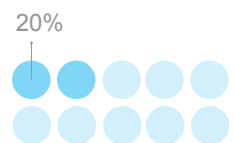

Triana

THE
CATALOGUE
2015



Values

About

CERTIFICATES:

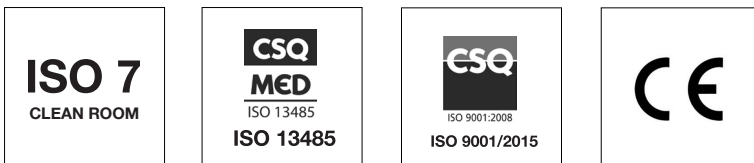

Our value chain

The highest value for Triana is the quality. Our staff possesses adequate training and knowledge to satisfy the needs of our clients.

We have been awarded the **DIN EN ISO 9001/2015**, **ISO 13485** standards, we are registered with the Health Ministry and we have the medical device facility operating licence. Some of our products also bear the **CE** marking and we are ready to obtain this for any other product that may be required by our customers. Not to mention, our specific facilities for our pharmaceutical customers.

We highlight the Sala Blanca in our facilities, with an **ISO-7** classification, an area of 175 sq. m and a transformation capacity of 2,520 kg/day. Within the Sala Blanca, we can perform finishes using screen printing, packaging, automatic assembly and manual assembly machines. We offer our customers an excellent platform to meet all their production requirements.

Our business is capable of satisfying from the production of few units up to the performance of fully fledged projects. We also provide advice on all the necessary technical aspects towards the customer obtaining excellence in the final product.

To achieve these objectives, at Triana, we consider **continuing professional training** as a key element to be competitive and to unite a strong productive team. As a result of this philosophy, we collaborate with the Fundació Ascamm, Barberà Promoció and Packaging Cluster to form our staff.

Our productive process

The flexibility and adaptability of the company can be seen in its productive process.

We manufacture all sorts of pieces for the food industry, such as tubes, saccharine holders, dispensers and spice racks in our facilities by the injection process. We also manufacture a wide range of products in the Sala Blanca for the pharmaceutical industry, such as vaginal applicators, dosing glasses, nebulisers, syringes, spoons and all sorts of plastic containers.

Our objective

Triana's objective is to produce products with a high added value and to strengthen the mutual trust with our customers.

At Triana, we believe in the true value of relationships. We will only achieve our objective with multi-directional relations and mutual cooperation. We currently collaborate with Packaging Cluster, Barberà Promoció and Ascamm.

Collaborations:

Packaging Cluster:
a group of local packaging companies.

Barberà Promoció:
Municipal economic promotion project. Provides training.

Sabadell Chamber of Commerce:
Provides services aimed at improving corporate competitiveness and strengthening their positioning in the market. Offers information on novelties, changes, trends, projects and initiatives that occur in the sphere of our professional activity.

The Private Ascamm Foundation:
It is a leading Industrial Technology Centre in Europe in what concerns the generation of technology oriented towards obtaining high added value products and the contribution of solutions that enable improving innovation management in companies.

Triana

THE
CATALOGUE
2015

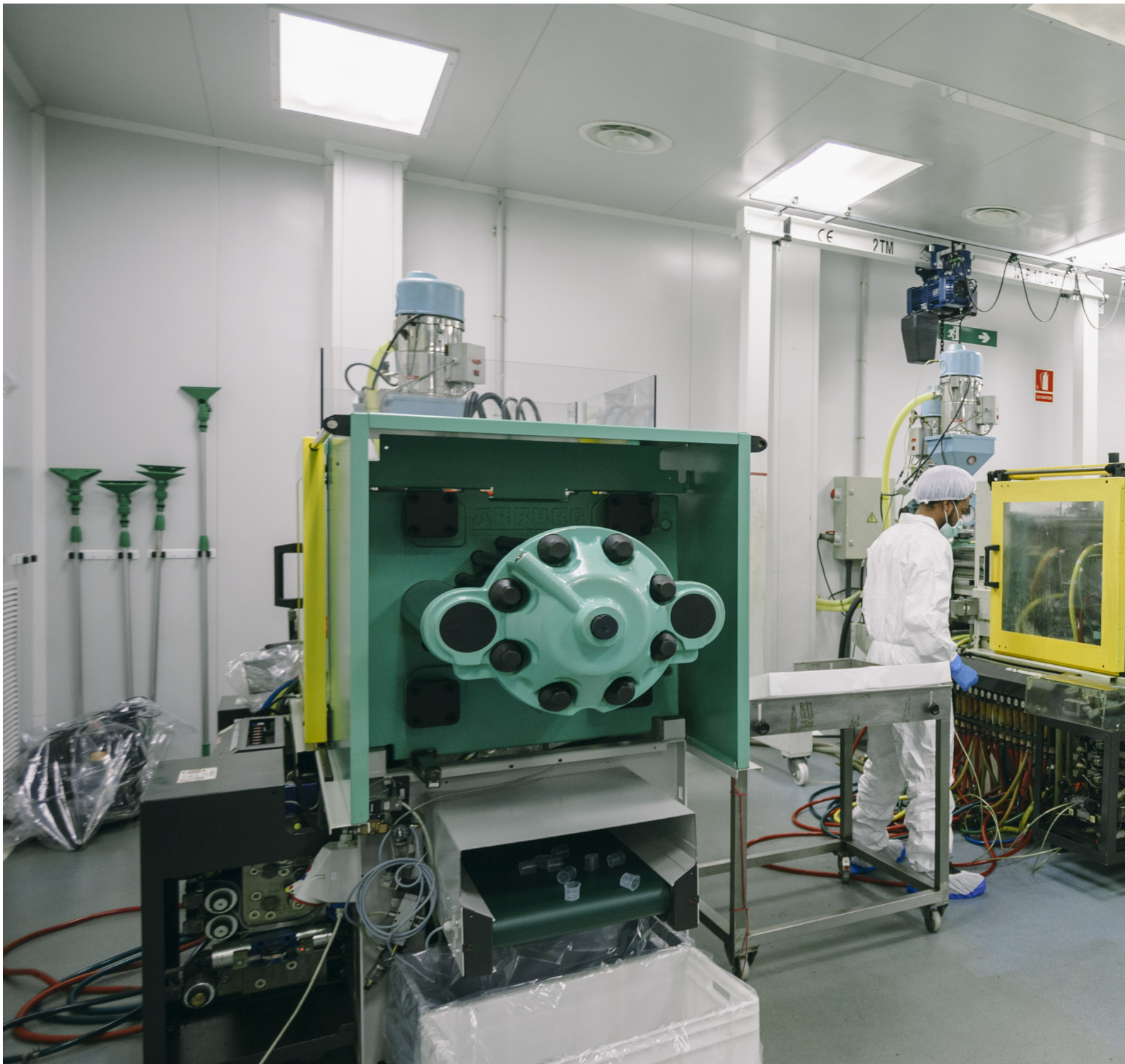



Triana

THE
CATALOGUE
2015

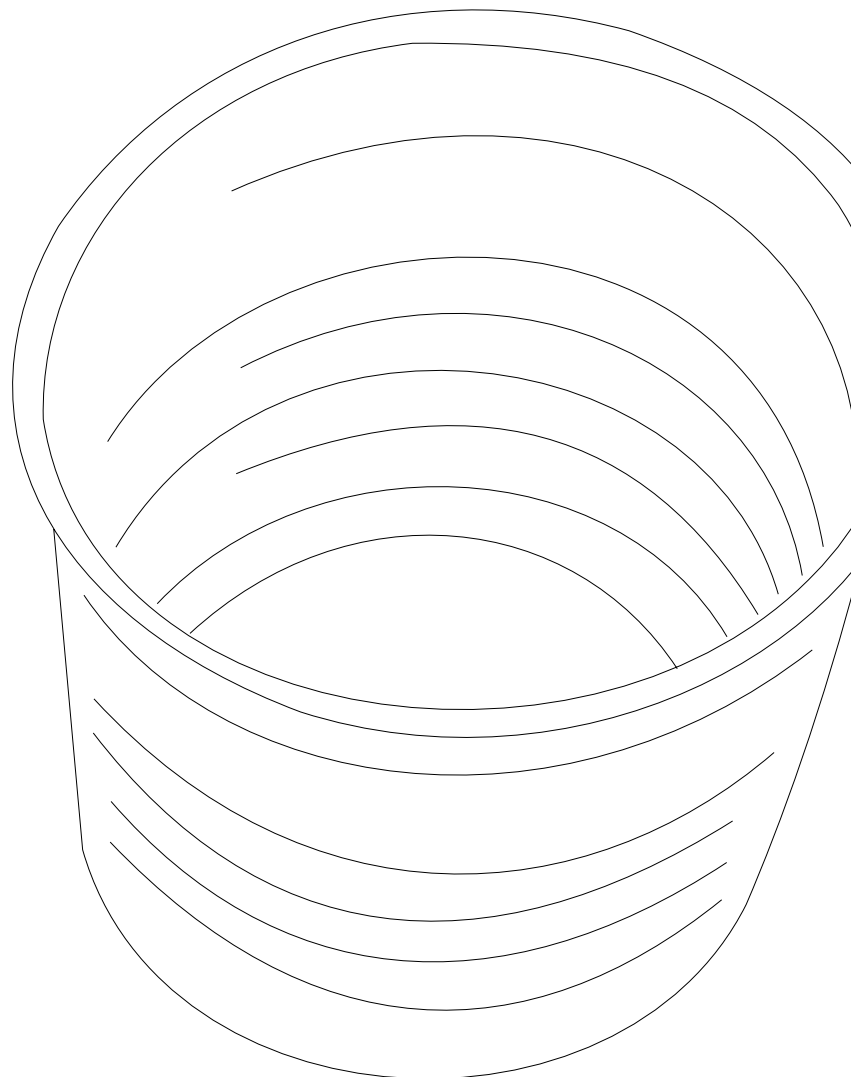
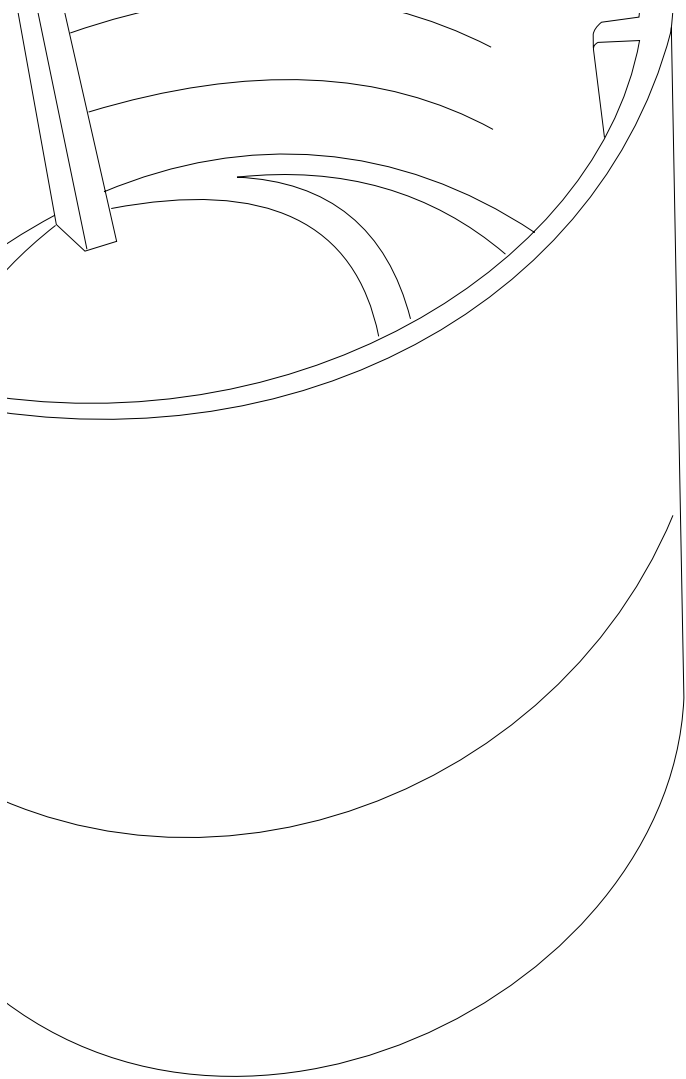

PHARMA

References

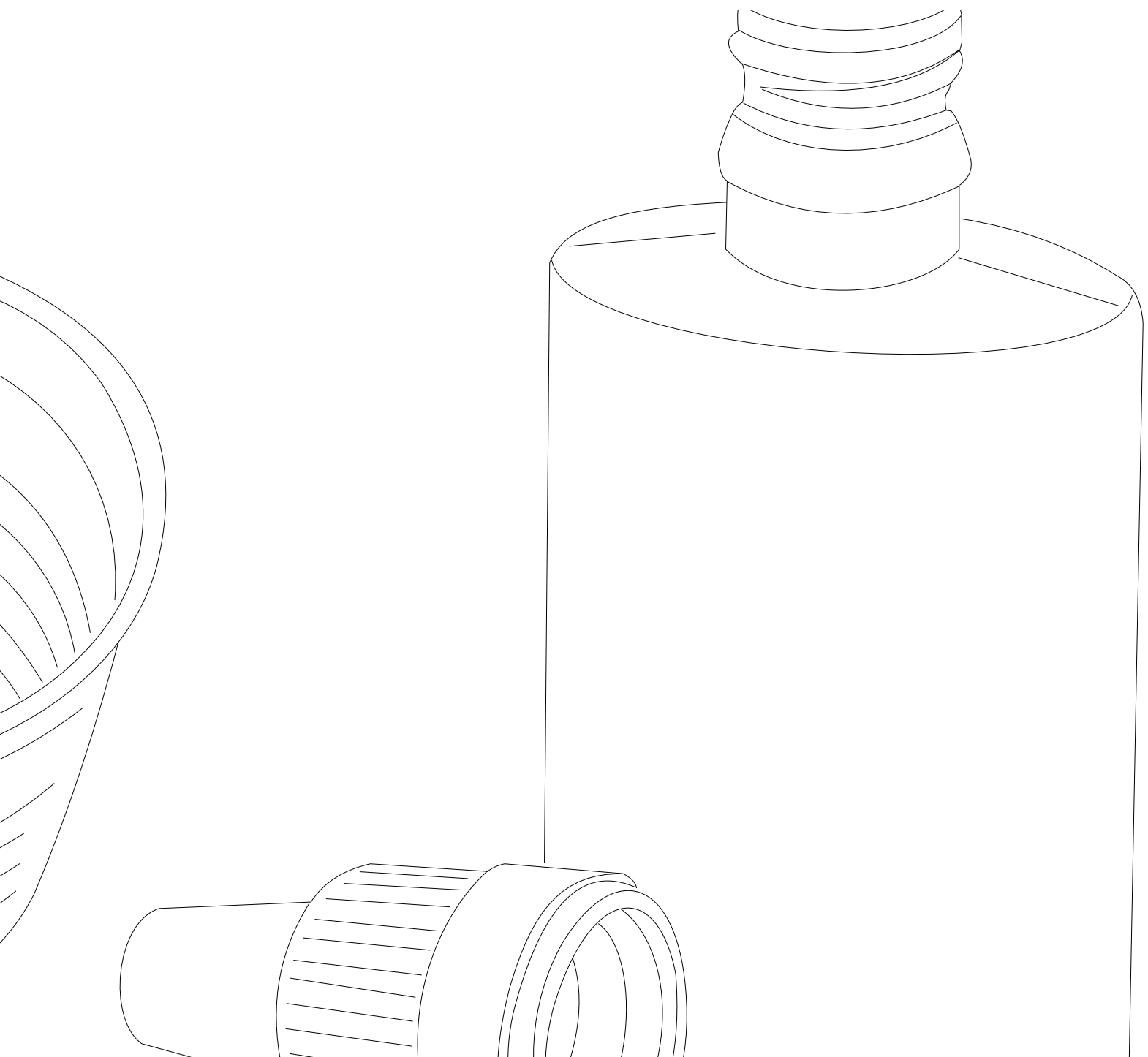

Index

Products and description

Measuring glasses

Measuring plastic glasses for pharmaceutical, food and plant applications. Cups with different capacity, height and scale. Syrup dosing cups.

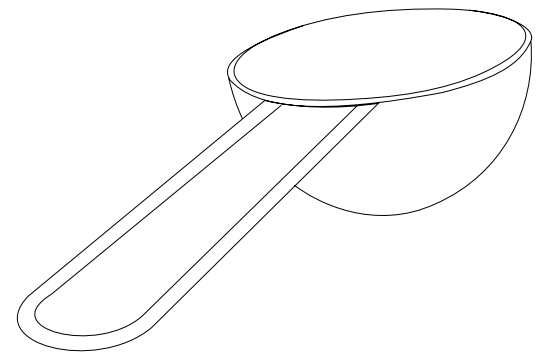
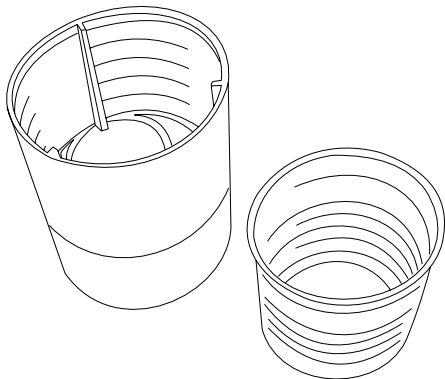

Medical measuring spoons

Measuring plastic spoons for food and pharmaceutical dosage. The spoon can be single or double capacity and optionally graded and individually wrapped.

Typical uses of these spoons: powdered drug dosage, syrups...

Measuring syringes

Plastic syringes for pharmacy and veterinary applications. Customized grading scale and printing for measuring purposes.

Each syringe can be supplied individually pocketed.

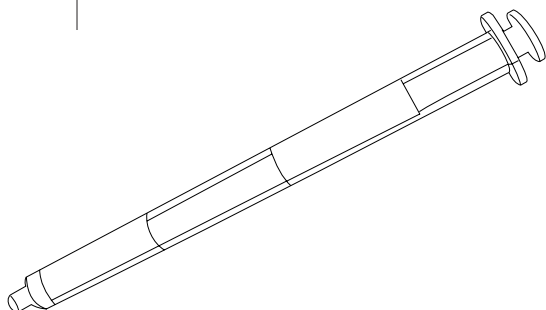

Pharma tubes

Plastic tubes and caps for applications in pharmaceutical, food and plant, with different diameter, height and capacity.

Typical uses of these tubes: pill box, tablet bottles, tablet containers...

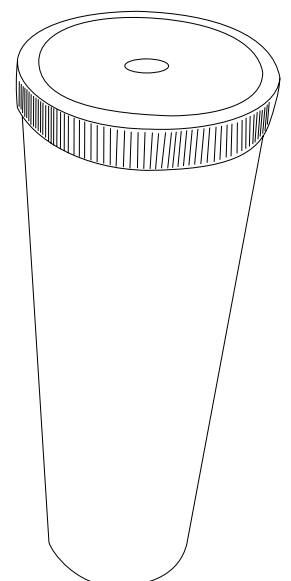

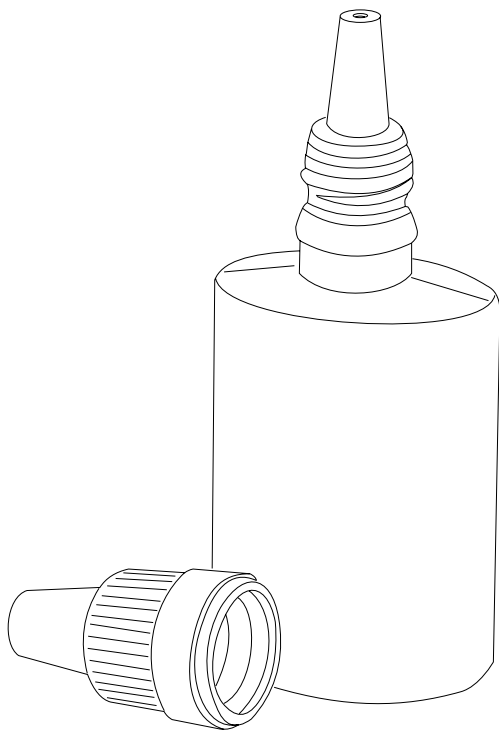

Nebulizer

Nasal spray in plastic container for pharmaceutical use, 30 ml capacity.

Supplied separately: the bottle, the cap + seal, and the nebulizer + cannula

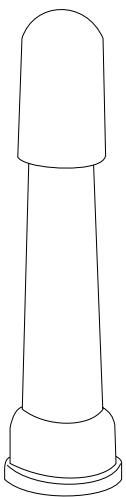

Canulae

Pharmacy rectal and vaginal plastic cannulae for tablets, creams and liquids.

Applicators can be delivered unitarily pocketed.

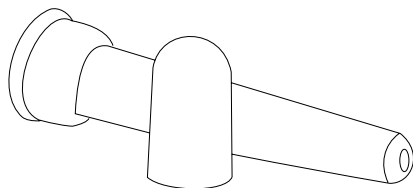

Applicators

Pharmacy rectal and vaginal plastic applicators and cannulas for tablets, creams and liquids.

Applicators can be delivered unitarily pocketed.

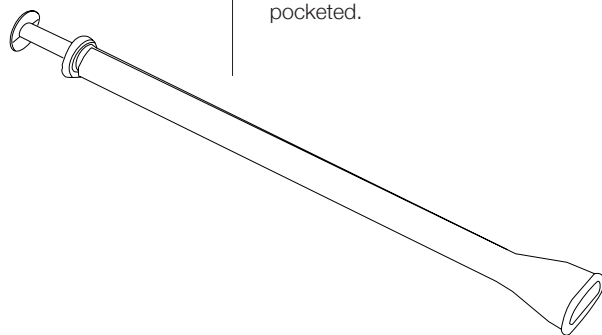

The facilities

Clean Room: Description and capacities

Classification room:

ISO 7

Surface:

175 m²

Volume:

610 m³

Clean Room machinery:

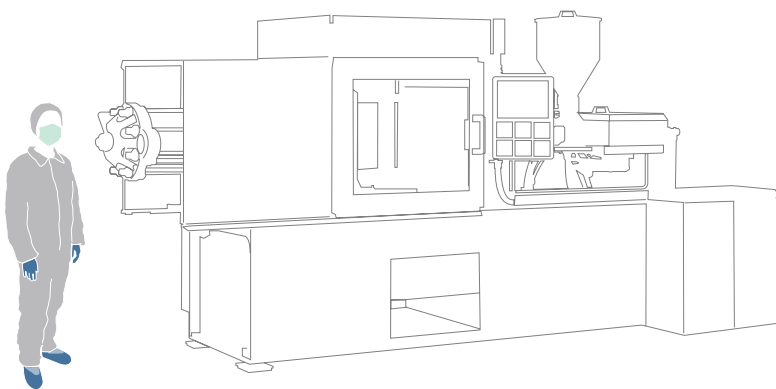

Equipment:

- Four 100 TN injection machines
- One 75 TN injection machine
- One screen printer
- Two assembly machines (tops with seal, nozzles with cannula)
- One PP film packaging machine
- Manual assembly area

Clean room modularity:

The way the hall is set out permits a high degree of adaptability according to the customer's requirements, thereby offering specific solutions.

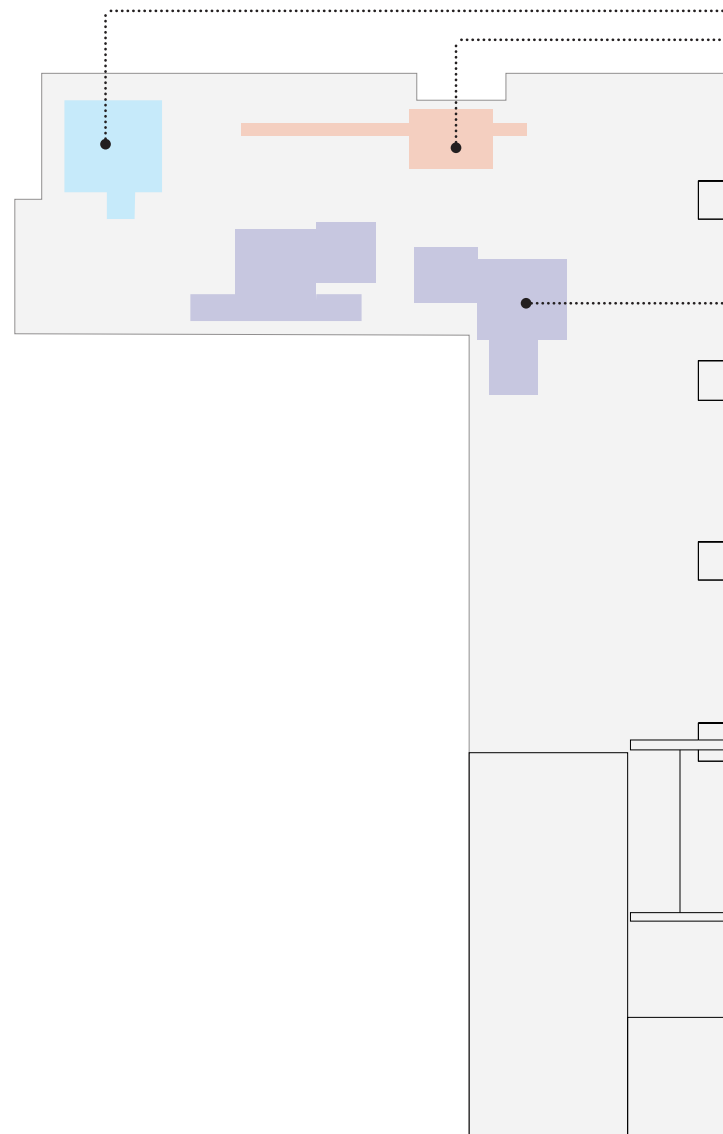

Some pieces produced in Clean room:

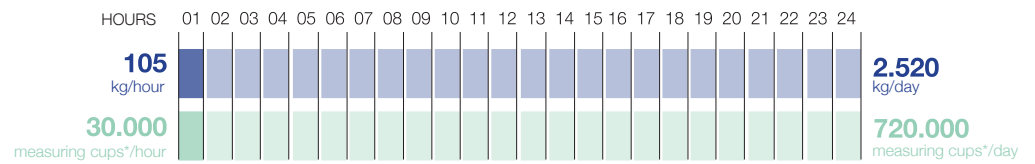
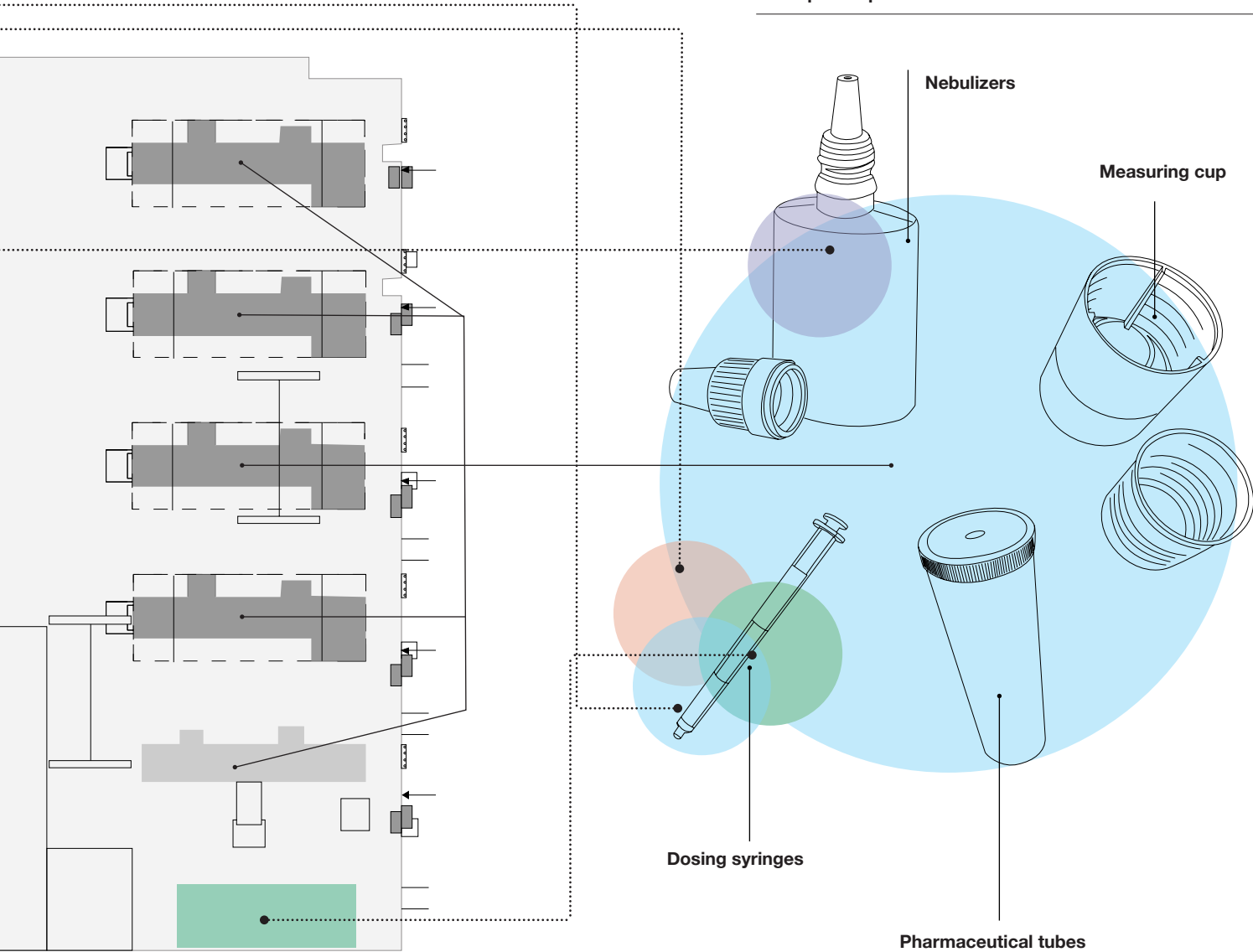

The protocol

Clean room: sanitary protocol

Cleaning staff of Clean room:

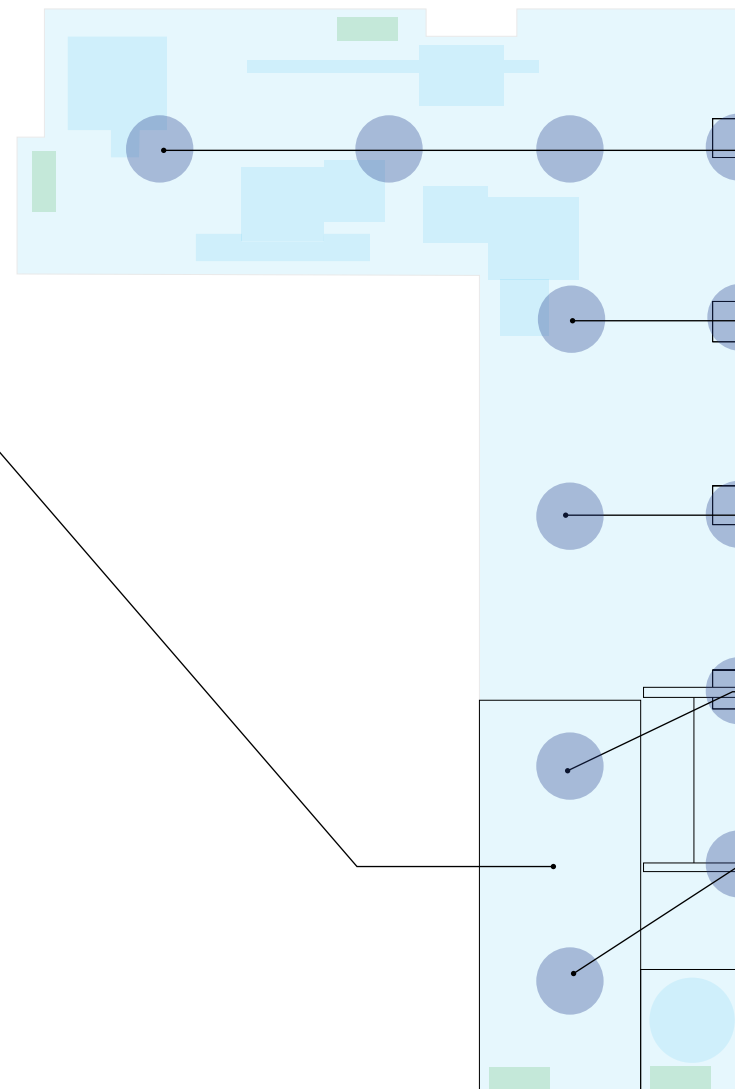
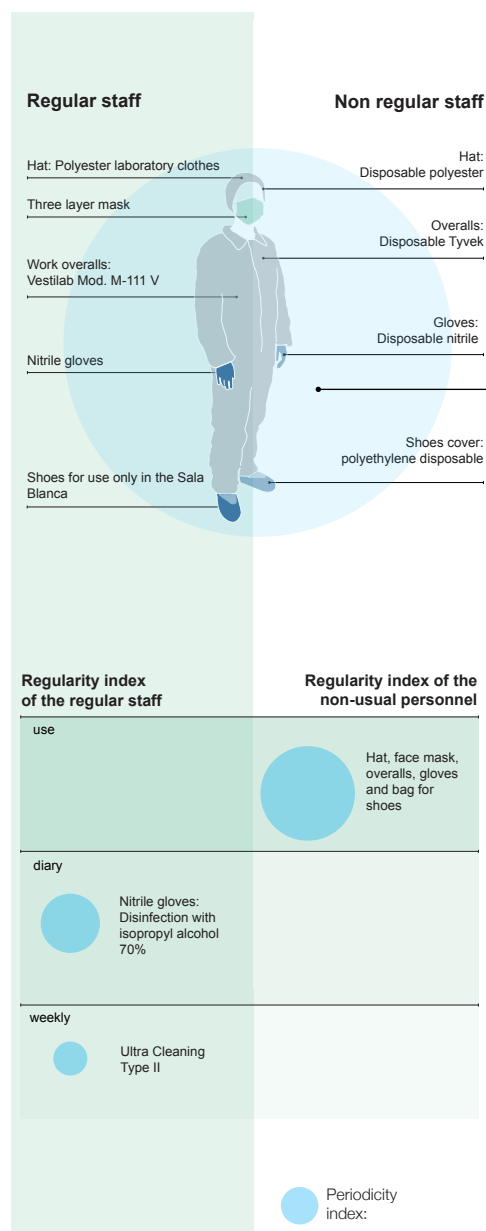

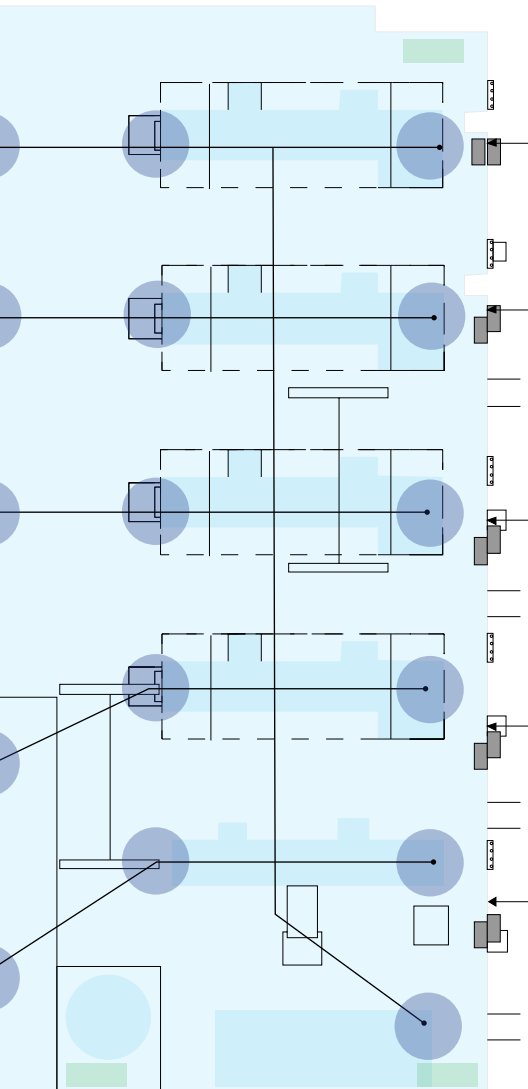

● leadership ■ return

Air renewal:

17 renewal/hour
10.400 m³/hour - 250.000 m³/day

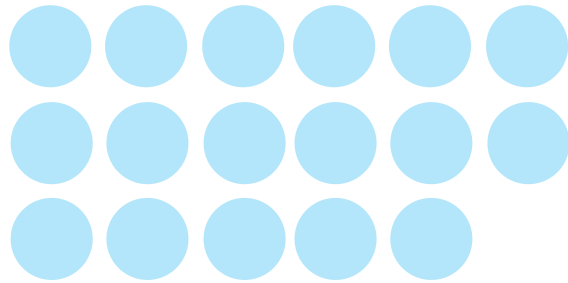

The hall has a decontamination system by air ultrafiltration. Air is introduced through two air conditioners to the protected area and has various pre-filtering stages before moving to the High-Efficiency absolute filtration section. Air recirculates and the required outside flow is added, 20% is provided to achieve the renewal of the room air..

Cleaning of the Clean room:

Regularity index:

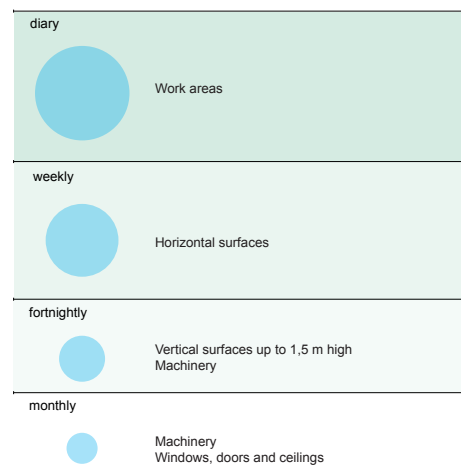

Triana

THE
CATALOGUE
2015



Measuring cups

References

Measuring plastic glasses for pharmaceutical, food and plant applications.

Cups with different capacity, height and scale. Syrup dosing cups.

Reference	Capacity (ml.)	Superior diameter	Inferior diameter	Height (mm.)	Level diameter	Scale graduation	Minimum order (u.)
0108	10,00	27,00	17,55	28,50	24,00	1,5-4,5-7,5	50.000
0110	10,00	27,30	17,40	28,55	24,00	5-10	50.000
3222	15,00	33,90	30,30	30,40	28,00	1,00-2,50-5,00-7,50-10,00-15,00	12.600
3233	15,00	33,90	30,30	30,40	28,00	2,50-5,00-7,50-10,00-15,00	28.800
0446	18,00	36,25	33,60	30,05	30,00	2,00-5,00-10,00-18,00	9.800
3204	20,00	38,35	26,05	37,70	24,00	2,50-5,00-7,50-10,00-20,00	7.500









Pharmaceutical tubes

References

Plastic tubes and caps for applications in pharmaceutical, food and plant, with different diameter, height and capacity.

Typical uses of these tubes: pill box, tablet bottles, tablet containers...

					
Reference	Approximate capacity (cm ³) total	Approximate capacity (cm ³) at 10mm. opening	Inner diameter (mm.)	Outer height (mm.)	Minimum order (u.)
	.				
0441	2	2	7,45	60,60	6.000
2202	14	10	21,25	41,00	10.000
0406	20	14	27,30	34,70	5.100
1805	23	19	24,60	50,00	-
3102	25	19	26,80	44,65	9.600
4001	30	23	29,20	45,20	12.500
0411	30	24	27,35	51,70	9.600
3113	31	27	21,15	89,40	11.200
0107	32	29	20,60	97,10	10.400
1806	39	31	32,80	47,00	4.500
0412	40	34	26,80	71,50	12.000
0413	43	35	32,60	52,60	4.800
3101	51	43	32,45	62,50	4.800
3201	54	48	26,50	98,30	4.950
0416	59	50	32,40	71,60	11.000
3325	67	55	35,40	60,50	4.400
0106	63	56	28,70	97,50	10.350
3301	68	60	32,50	83,10	6.500
3116	88	76	37,90	78,10	11.200
3001	117	110	45,65	71,70	4.000

Triana

THE
CATALOGUE
2015

PHARMACEUTICAL TUBES REFERENCES



Ordered by capacity (cm³)

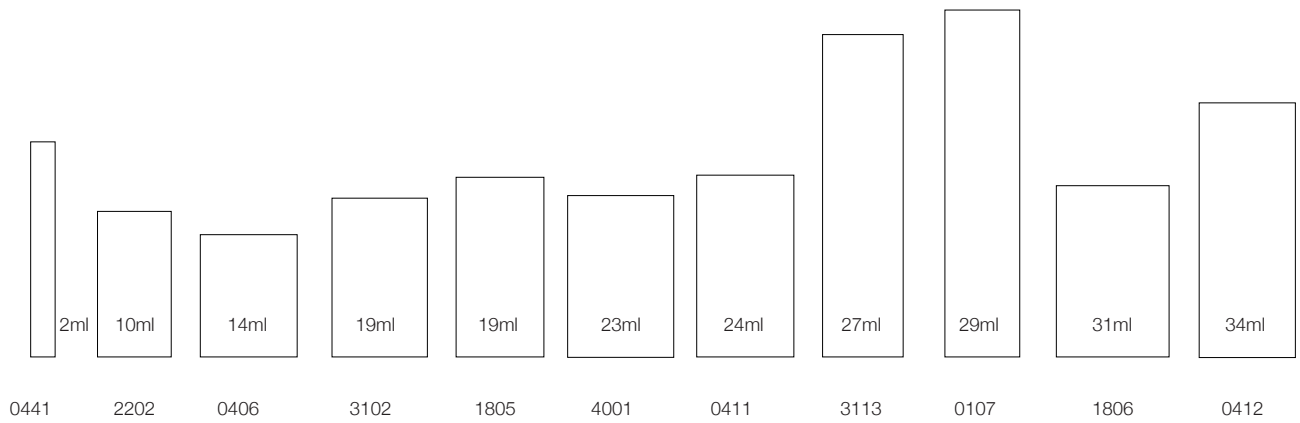

Lids available

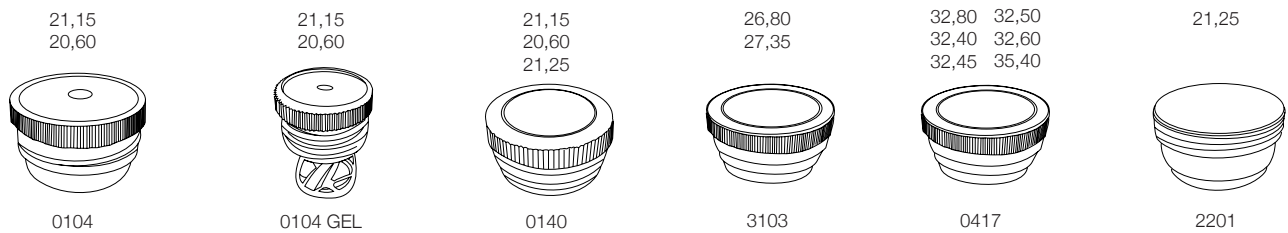

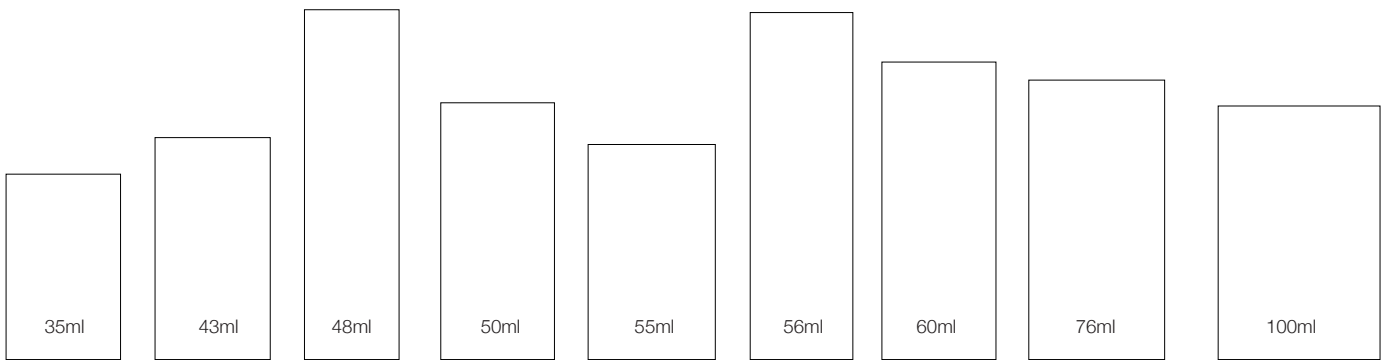
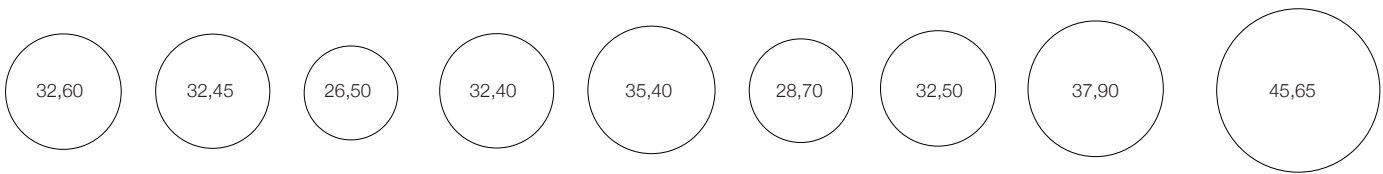

0413 3101 3201 0416 3325 0106 3301 3116 3001

26,80 32,60 28,70 28,70 37,90 45,65

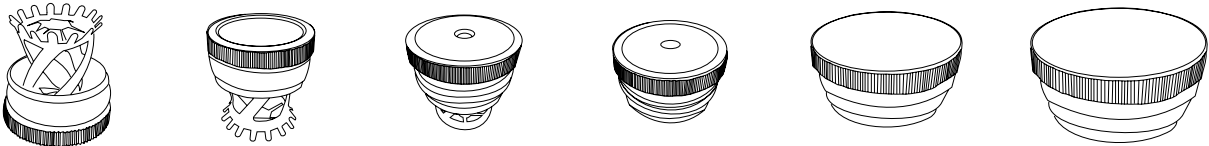

0436 0438 0421M 0421 3117 3002

Triana

THE
CATALOGUE
2015



Measuring syringes

References

Plastic syringes for pharmacy and veterinary applications.
Customized grading scale and printing for measuring purposes.

Each syringe can be supplied individually pocketed.

ref	ml	ud.	
Reference	Capacity (ml.)	Minimum order (u.)	Notes
3114	2,00	6.000	Custom printed
3118	3,00	2.500	Custom printed

Triana

THE
CATALOGUE
2015







Measuring spoons

References

Measuring plastic spoons for food and pharmaceutical dosage. The spoon can be single or double capacity and optionally graded and individually wrapped.

Typical uses of these spoons: powdered drug dosage, syrups...

				
Reference	Capacity 1 (ml.)	Capacity 2 (ml.)	Minimum order (u.)	Notes
	.			
0803	1,25	0	34.000	-
0429	5,00	0	9.000	-
0704	5,00	0	18.000	-
3242	5,00	2,50	3.500	double
0434	10,00	5,00	6.000	double

Triana

THE
CATALOGUE
2015

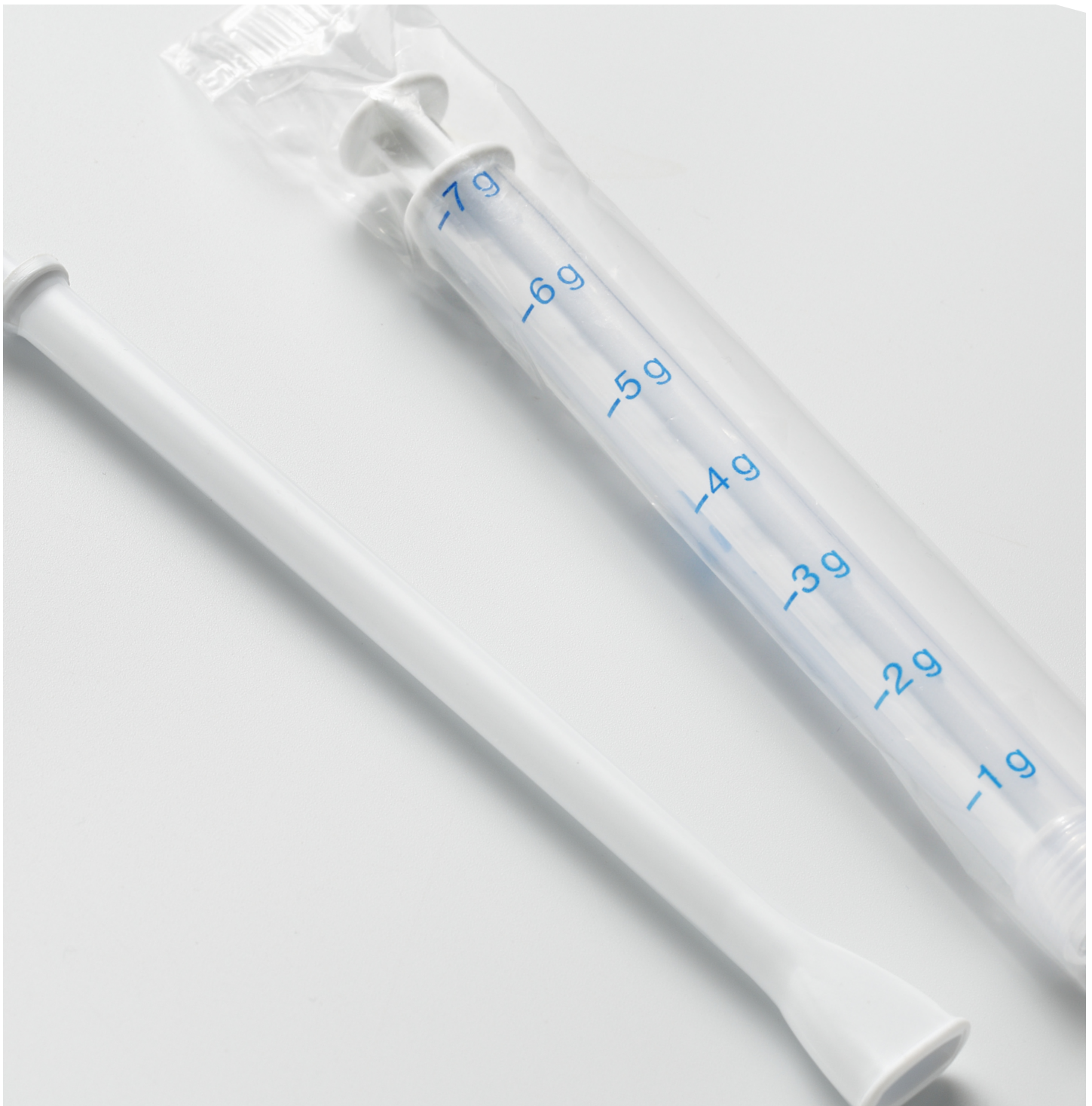

Applicators

References

Pharmacy rectal and vaginal plastic applicators and cannulas for tablets, creams and liquids.

Applicators can be delivered unitarily pocketed.

ref	ud.		Reference	Use	Minimum order (u.)	Notes
.						
			1415	Vaginal cream applicator	6.300	Custom printed
			1414	Vaginal tablet applicator	3.000	-

Triana

THE
CATALOGUE
2015



Canulae

References

Pharmacy rectal and vaginal plastic cannulae for tablets, creams and liquids.

Applicators can be delivered unitarily pocketed.



Reference	Use	Notes
.		
1413	Rectal cream canulae	-

Triana

THE
CATALOGUE
2015





Nebulizers

References

Nasal spray in plastic container for pharmaceutical use, 30 ml capacity.

Supplied separately: the bottle, the cap + seal, and the nebulizer + cannula

ref			ml
Reference	Description	Measures (mm.)	Capacity (ml.)
.			
NEB-30	Nasal nebulizer	40,00 x 25,00 x 95,00	30

Triana

THE
CATALOGUE
2015



**Industrias Plásticas
Triana, S.A.**

Pol. Ind. Santiga
C/ Can Magí, 12
08210
Barberà del Vallès
Barcelona
Spain

t.: +34 93 719 11 67
f.: +34 93 719 05 29

www.ip triana.com
 [triana@ip triana.com](mailto: triana@ip triana.com)

Impreso con papel
libre de cloro.